

Soft Top Install

RG-100-RZR2 & RG-100-RZR4

Please read instructions carefully before installation. We recommend this product be installed by a qualified, and experienced technician. If you are unsure of any of the below directions and or your ability to correctly and securely install this product, please contact us or your local dealer for help. Below diagrams show typical installation, your vehicle may be different so please use diagrams as a guide. Make sure your vehicle is clean and free from dirt, road grime, etc. where the this product mounts. It is the drivers responsibility to make sure the product is mounted and secure before each use. **Always check for proper mounting and that straps are tight before each and every drive.**

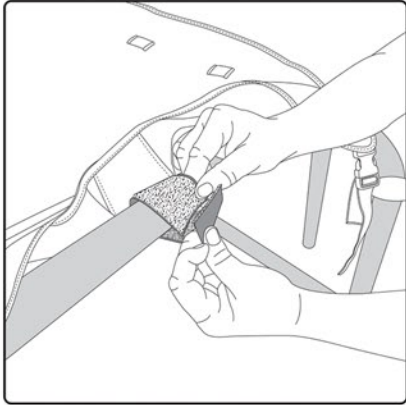

After placing the soft top over your stock roll cage, secure the self-fastening straps from underneath to the roll bar.

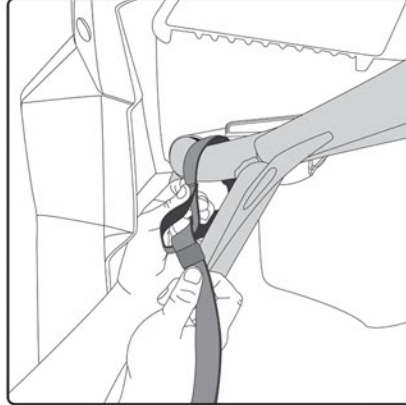

To secure the front, remove the male buckle from one of the straps with a loop and pass around the roll bar located above front wheels under the vehicle.

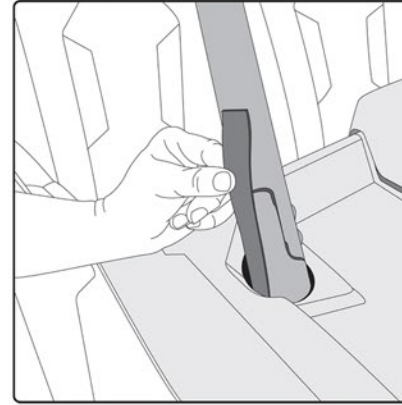

Once secure on the roll bar, feed the end up through the hole where the roll bar meets the side of the hood plastics. Connect to the female buckle on the soft roof and pull snug but not tight.

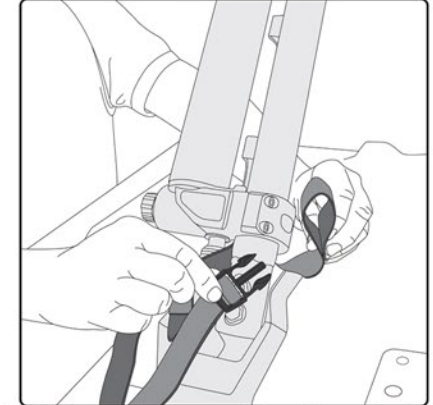

Attach the rear straps around the roll bar under the shock by passing the strap through the webbing loop and pull tight. Connect to the female buckle on the soft roof and pull snug but not tight.

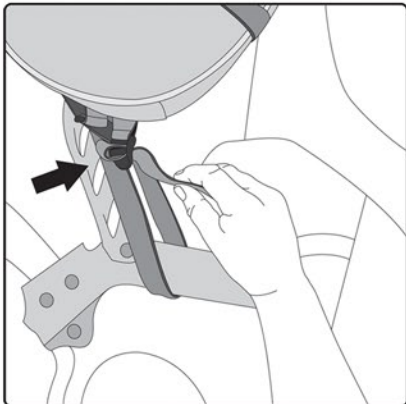

Attach the side straps around the roll bar under the seat belt bolts by passing the strap through the webbing loop and pull tight. Connect to the female buckle on the soft roof and pull snug but not tight.

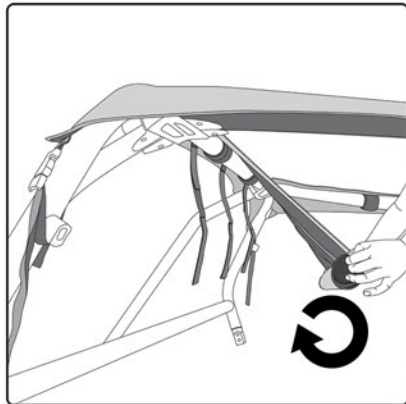

When opening the sunroof. Unzip and roll back as shown. It is important for the roll to go towards the back under the zippered panel.

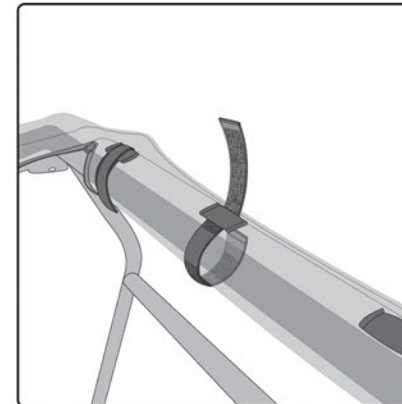

Once rolled tightly and under the roll bar, pass the self-fastening straps around the roll bar and then around the tightly rolled panel. Insert the strap thru the loop on the top of the cover, then attach to itself.

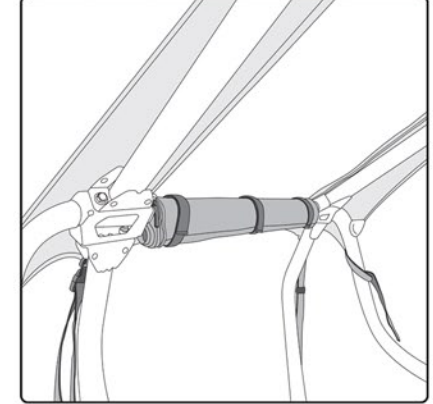

Repeat for all three remaining straps and make sure rolled panel is secure.

Warning

Read the installation instructions and make yourself familiar with the process of installing the Rigg Gear product(s) on your vehicle. It is your responsibility to install the product(s) correctly and securely as outlined in these instructions. Rigg Gear products must not be overloaded or over tightened. Failure to adhere to these warnings may result in, but not limited to, the product becoming detached, becoming tangled in moving parts of the vehicle, unstable vehicle dynamics, reduction in the ability to control the vehicle. The result(s) could lead to serious injury.

Always drive safely. Always wear a helmet and protective apparel.

3518-A Lake Center Dr Santa Ana, CA 92704
Tel (714)850-1811 Fax (714)850-1848
e-mail: info@RiggGear.com www.RiggGear.com

